

Smart-UPSTM C

Uninterruptible Power Supply

**420/620 VA
110/120/230 Vac**

**Tower
English**

Introduction

The APC™ by Schneider Electric Smart-UPS™ product name is a high performance uninterruptible power supply (UPS). The UPS provides protection for electronic equipment from utility power blackouts, brownouts, sags, surges, small utility power fluctuations and large disturbances. The UPS also provides battery backup power for connected equipment until utility power returns to safe levels or the batteries are fully discharged.

This user manual is available on the enclosed CD and on the APC by Schneider Electric web site, www.apc.com.

1: INSTALLATION

Unpack

Attention: Read the safety instruction sheet before installation.

Inspect the UPS upon receipt. Notify the carrier and dealer if there is damage.

The packaging is recyclable; save it for reuse or dispose of it properly.

Check the package contents:

Attention: The UPS comes with battery disconnected.

- UPS
- UPS literature kit containing:
 - Product documentation, safety and warranty information
 - Documentation CD
 - PowerChute™ CD
 - Serial communication cable
 - 230 V models: Two jumper cables

Position the UPS

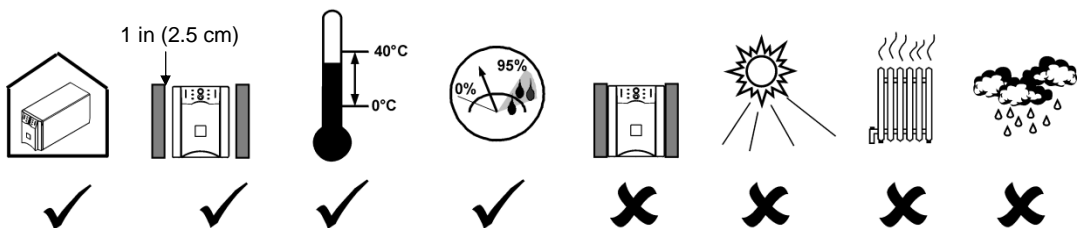

2: START UP

Connect the Battery

1

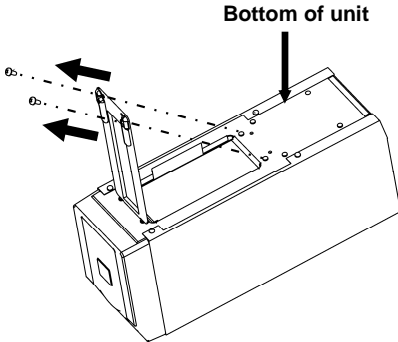

2

Connect black wire to battery. (Red wire is already connected.) Note: Small sparks at the point of battery connection are normal.

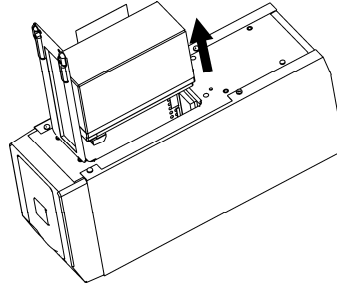

3

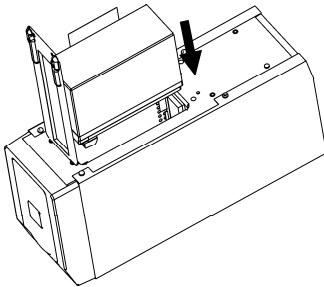

4

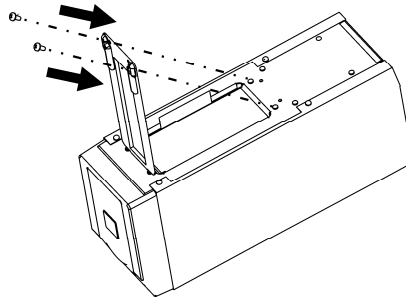

Connect Equipment to the UPS

Rear Panels

110/120 V:

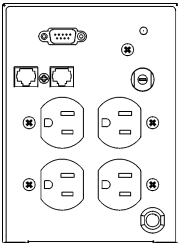

230 V:

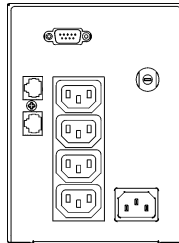

- *230 V models:* The top off white outlet provides surge protection only. Equipment plugged into this 500 VA outlet should require surge protection, but should not require power during a utility power failure. The lower three outlets provide battery backup protection, as well as protection from surges.
- Note: A laser printer draws significantly more power than other types of equipment and may overload the UPS.

Connect the UPS to the Network (if Applicable)

Network Connectors

Serial Port

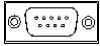

Telephone/Network

Surge Suppression Ports



Use only interface kits approved by APC by Schneider Electric.

Use only the supplied cable to connect to the Serial Port. A standard serial interface cable is incompatible with the UPS.

The UPS features optional telephone/network surge suppression. Connect a single line telephone or a 10 Base-T/ 100 Base-Tx network cable into the RJ-45/RJ-11 telephone/network surge protection IN jack on the back of the UPS. Use a telephone cable (not supplied) or network cabling (not supplied) to connect the OUT jack to a fax modem or network port.

Start the UPS

1. Plug the UPS into a two pole, three wire, grounded receptacle only. Avoid using extension cords.

110/120 V models: The power cord is attached to the UPS. The input plug is a NEMA 5-15P.

230 V models: The power cord set is supplied in the UPS literature kit. **Attention: Upon utility power connection, the top outlet is immediately powered; the bottom three outlets are powered after the UPS performs the self-test.**

2. *110/120 V models:* Check the *site wiring fault* LED  located on the rear panel. It will be illuminated if the UPS is plugged into an improperly wired utility power outlet (see *Troubleshooting*).
3. Turn on all connected equipment. To use the UPS as a master *on/off* switch, be sure all connected equipment is on.
4. Press the button on the front panel to power the UPS.





Note: The battery charges fully during the first four hours of normal operation. Do not expect full battery run capability during this initial charge period. Refer to www.apc.com for battery runtimes.

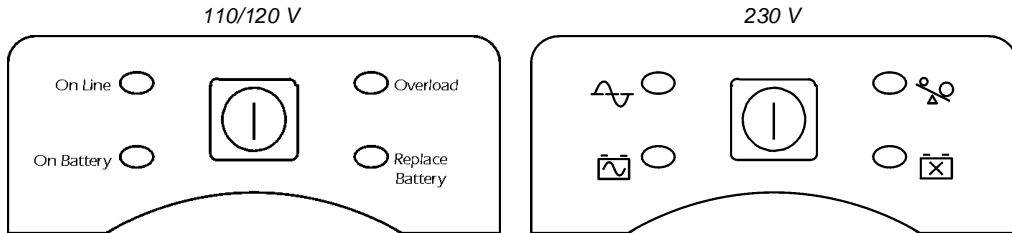

5. For optimal computer system protection, install PowerChute management software to fully configure UPS shutdown and alarm settings.

3: OPERATION

Front Display Panel



INDICATOR	DESCRIPTION
On Line 	The UPS is supplying utility power to the connected equipment.
On Battery 	The UPS is supplying battery power to the connected equipment.
Overload 	The connected loads are drawing more than the UPS power rating.
Replace Battery 	The battery must be replaced.

FEATURE	FUNCTION
Power Button 	Press this button to turn the UPS on or off. (Read on for additional capabilities.)
Self-Test	<p>Automatic: The UPS performs a self-test automatically when turned on, and every two weeks thereafter (by default). During the self-test, the UPS briefly operates the connected equipment on battery.</p> <p>Manual: Press and hold the  button for a few seconds to initiate the self-test.</p>
Cold Start	Supply battery power to the UPS and connected equipment in the absence of utility voltage (see <i>Troubleshooting</i>). Press the  button for one second and release. The UPS will beep briefly and go quiet. Press and hold the button again, but for approximately three seconds. The unit will emit a sustained beep. Release the button during this beep.

4: USER CONFIGURABLE ITEMS

NOTE: SETTINGS ARE ADJUSTED THROUGH POWERCHUTE SOFTWARE			
FUNCTION	FACTORY DEFAULT	USER SELECTABLE CHOICES	DESCRIPTION
Automatic Self-Test	Every 14 days (336 hours)	Every 7 days (168 hours), Every 14 days (336 hours), On Startup Only, No Self-Test	Set the interval at which the UPS will execute a self-test.
UPS ID	UPS_IDEN	Up to eight characters (alphanumeric)	Uniquely identify the UPS, (i.e. server name or location) for network management purposes.
Date of Last Battery Replacement	Manufacture Date	mm/dd/yy	Reset this date when you replace the battery module.
Minimum Capacity Before Return from Shutdown	0 percent	0, 15, 50, 90 percent	Specify the percentage to which batteries will be charged following a low battery shutdown before powering connected equipment.
Voltage Sensitivity The UPS detects and reacts to line voltage distortions by transferring to battery operation to protect connected equipment.	High	High sensitivity, Medium sensitivity, Low sensitivity	Note: In situations of poor power quality, the UPS may frequently transfer to battery operation. If the connected equipment can operate normally under such conditions, reduce the sensitivity setting to conserve battery capacity and service life.
Alarm Delay After Line Fail	5 seconds	5 second delay, 30 second delay, At low battery condition, No alarm	Set the delay to avoid alarms for minor power glitches.
Shutdown Delay	60 seconds	60, 180, 300, 600 seconds	Set the interval between the time when the UPS receives a shutdown command and the actual shutdown.

NOTE: SETTINGS ARE ADJUSTED THROUGH POWERCHUTE SOFTWARE

FUNCTION	FACTORY DEFAULT	USER SELECTABLE CHOICES	DESCRIPTION
Low Battery Warning	2 minutes PowerChute Business Edition software provides automatic, unattended shut down when approximately 2 minutes of battery operated runtime remains.	2, 5, 7, 10 minutes (Times are approximate.)	The UPS will beep when 2 minutes of battery runtime remains. Change the low battery warning interval setting to the time that the operating system or system software requires to safely shut down.
Synchronized Turn-on Delay	0 seconds	0, 60, 180, 300 seconds	Specify the time the UPS will wait after the return of utility power before turn-on (to avoid branch circuit overload).
High Transfer Point	<i>110/120 V model:</i> 127 Vac <i>230 V model:</i> 253 Vac	<i>110/120 V model:</i> 127, 130, 133, 136 Vac <i>230 V model:</i> 253, 257, 261, 265 Vac	Set the high transfer point higher to avoid unnecessary battery usage when the utility voltage is usually high and the connected equipment is specified to operate with input voltages this high.
Low Transfer Point	<i>110/120 V model:</i> 106 Vac <i>230 V model:</i> 208 Vac	<i>110/120 V model:</i> 97, 100, 103, 106 Vac <i>230 V model:</i> 196, 200, 204, 208 Vac	Set the low transfer point lower when the utility voltage is usually low and the connected equipment is specified to operate with input voltages this low.

5: STORAGE AND MAINTENANCE

Storage

Store the UPS covered in a cool, dry location, with the battery fully charged.

At -15° to $+30^{\circ}$ C ($+5^{\circ}$ to $+86^{\circ}$ F), charge the UPS battery every six months.

At $+30^{\circ}$ to $+45^{\circ}$ C ($+86^{\circ}$ to $+113^{\circ}$ F), charge the UPS battery every three months.

Battery Replacement

The UPS battery life differs based on usage and environment. Consider replacing the battery every three years.

This UPS has an easy to replace, hot-swappable battery. Replacement is a safe procedure, isolated from electrical hazards. You may leave the UPS and connected equipment on during the replacement procedure. See your dealer or contact APC by Schneider Electric (see *Contact Information*) for information on replacement batteries.

Note: Upon battery disconnection, equipment is not protected from power outages.

1

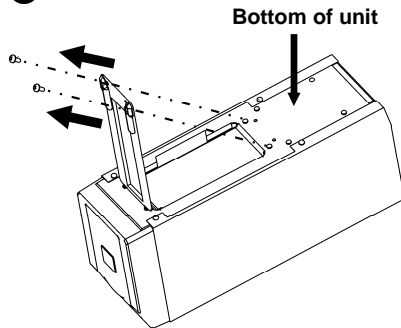

2

Disconnect the battery wires.

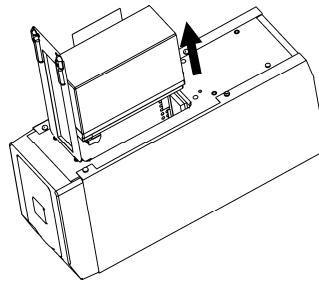

3

Connect the new battery by matching red and black wires and connectors. Note: Small sparks at the point of battery connection are normal.

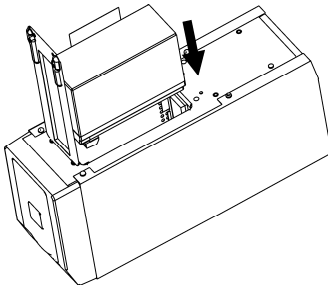

4

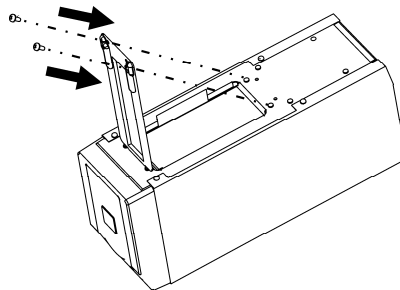

Be sure to deliver the spent battery to a recycling facility or ship it to APC by Schneider Electric in the replacement battery packing material.

6: TROUBLESHOOTING, TRANSPORT, AND SERVICE

Use the chart below to solve minor UPS installation and operation problems. Refer to www.apc.com with complex UPS problems, and for battery runtime charts.

PROBLEM AND/OR POSSIBLE CAUSE	SOLUTION
<i>UPS WILL NOT TURN ON</i>	
UPS not connected to utility power supply.	Check that the power cord from the UPS to the utility power supply is securely connected at both ends.
Battery not connected properly.	Check that battery is properly connected.
Very low or no utility voltage.	Check the utility power supply to the UPS by plugging in a table lamp. If the light is very dim, have the utility voltage checked.
<i>UPS WILL NOT TURN OFF</i>	
Internal UPS fault.	Do not attempt to use the UPS. Unplug the UPS, unplug the battery, and have it serviced immediately.
<i>UPS BEEPS OCCASIONALLY</i>	
Normal operating UPS beeps when running on battery.	None. The UPS is protecting the connected equipment from occasional utility power irregularities.
<i>UPS IS NOT PROVIDING EXPECTED BACKUP TIME</i>	
The UPS battery is weak due to a recent outage or is near the end of the service life.	Charge the battery. Batteries require recharging after extended outages, and wear faster when frequently put into service or when operated at elevated temperatures. If the battery is near the end of the service life, consider replacing even if the <i>replace battery</i> LED is not yet illuminated.
<i>ON-LINE AND OVERLOAD LEDS ARE FLASHING ALTERNATELY</i>	
The UPS was shut down through PowerChute.	None. The UPS will restart when utility power returns.
<i>ALL LEDS ARE FLASHING OR ON-LINE AND ON-BATTERY LEDS ARE FLASHING</i>	
Internal UPS fault. The UPS has shut down.	Do not attempt to use the UPS. Turn off the UPS, disconnect the battery, and have it serviced immediately.
<i>ALL LEDS ARE OFF AND THE UPS IS PLUGGED INTO A WALL OUTLET</i>	
The UPS is shut down or the battery is discharged from an extended outage.	None. The UPS will return to normal operation when the power is restored and the battery has a sufficient charge.

PROBLEM AND/OR POSSIBLE CAUSE	SOLUTION
THE OVERLOAD LED IS ILLUMINATED AND THE UPS EMITS A SUSTAINED ALARM TONE	
The UPS is overloaded. The connected equipment is drawing more VA than the UPS can sustain.	<p>The connected equipment exceeds the specified “maximum load.”</p> <p>The alarm remains on until the overload is removed. Disconnect nonessential equipment from the UPS to eliminate the overload.</p> <p>The UPS continues to supply power as long as it is online and the circuit breaker does not trip; the UPS will not provide power from batteries in the event of a utility voltage interruption.</p> <p>If a continuous overload occurs while the UPS is on battery, the unit turns off output in order to protect the UPS from possible damage.</p>
THE REPLACE BATTERY LED IS ILLUMINATED	
Weak battery.	Allow the battery to recharge for 24 hours. Then, perform a self-test. If the problem persists after recharging, replace the battery.
Failure of a battery self-test.	The UPS emits short beeps for one minute and the <i>replace battery</i> LED illuminates. The UPS repeats the alarm every five hours. Perform the self-test procedure after the battery has charged for 24 hours to confirm the <i>replace battery</i> condition. The alarm stops and the LED clears if the battery passes the self-test.
THE SITE WIRING FAULT LED ON THE REAR PANEL IS ILLUMINATED (110/120 V MODEL ONLY)	
The UPS is plugged into an improperly wired utility power outlet.	<p>Wiring faults detected include missing ground, hot-neutral polarity reversal, and overloaded neutral circuit.</p> <p>Contact a qualified electrician to correct the building wiring.</p>
THE INPUT CIRCUIT BREAKER HAS TRIPPED	
The UPS is overloaded. The plunger on the circuit breaker has popped out.	Reduce the load on the UPS by unplugging equipment. Press in the plunger on the circuit breaker.
UPS OPERATES ON BATTERY ALTHOUGH UTILITY VOLTAGE EXISTS	
The UPS input circuit breaker has tripped.	To reduce the load on the UPS, unplug equipment and press in the plunger on the circuit breaker.
The line voltage is very high, low or distorted.	Move the UPS to a different outlet on a different circuit, as inexpensive fuel powered generators may distort the voltage. If acceptable to the connected equipment, reduce the UPS sensitivity (see <i>User Configurable Items</i>).
ON-LINE LED	
There is no illumination.	The UPS is running on battery, or it must be turned on.
The LED is blinking.	The UPS is running an internal self-test.

Transport

- 1 . Shut down and disconnect all connected equipment.
- 2 . Disconnect the unit from utility power.
- 3 . Disconnect all internal and external batteries (if applicable).
- 4 . Follow the shipping instructions outlined in the *Service* section of this manual.

Service

If the unit requires service, do not return it to the dealer. Follow these steps:

- 1 . Review the *Troubleshooting* section of the manual to eliminate common problems.
- 2 . If the problem persists, contact APC by Schneider Electric Customer Support through the APC by Schneider Electric web site, **www.apc.com**.
 - a. Note the model number and serial number and the date of purchase. The model and serial numbers are located on the rear panel of the unit and are available through the LCD display on select models.
 - b. Call Customer Support and a technician will attempt to solve the problem over the phone. If this is not possible, the technician will issue a Returned Material Authorization Number (RMA#).
 - c. If the unit is under warranty, the repairs are free.
 - d. Service procedures and returns may vary internationally. Refer to the APC by Schneider Electric web site, **www.apc.com** for country specific instructions.
- 3 . Pack the unit properly to avoid damage in transit. Never use foam beads for packaging. Damage sustained in transit is not covered under warranty.
 - a. **Note: When shipping within the United States, or to the United States always DISCONNECT ONE UPS BATTERY before shipping in compliance with U.S. Department of Transportation (DOT) and IATA regulations.** The internal batteries may remain in the UPS.
 - b. Batteries may remain connected in the XBP during shipment. Not all units utilize XLBPs.
- 4 . Write the RMA# provided by Customer Support on the outside of the package.
- 5 . Return the unit by insured, prepaid carrier to the address provided by Customer Support.

7: LIMITED FACTORY WARRANTY

Schneider Electric IT Corporation (SEIT), warrants its products to be free from defects in materials and workmanship for a period of two (2) years from the date of purchase. The SEIT obligation under this warranty is limited to repairing or replacing, at its own sole option, any such defective products. Repair or replacement of a defective product or parts thereof does not extend the original warranty period.

This warranty applies only to the original purchaser who must have properly registered the product within 10 days of purchase. Products may be registered online at warranty.apc.com.

SEIT shall not be liable under the warranty if its testing and examination disclose that the alleged defect in the product does not exist or was caused by end user or any third person misuse, negligence, improper installation, testing, operation or use of the product contrary to SEIT recommendations or specifications. Further, SEIT shall not be liable for defects resulting from: 1) unauthorized attempts to repair or modify the product, 2) incorrect or inadequate electrical voltage or connection, 3) inappropriate on site operation conditions, 4) Acts of God, 5) exposure to the elements, or 6) theft. In no event shall SEIT have any liability under this warranty for any product where the serial number has been altered, defaced, or removed.

EXCEPT AS SET FORTH ABOVE, THERE ARE NO WARRANTIES, EXPRESS OR IMPLIED, BY OPERATION OF LAW OR OTHERWISE, APPLICABLE TO PRODUCTS SOLD, SERVICED OR FURNISHED UNDER THIS AGREEMENT OR IN CONNECTION HEREWITH.

SEIT DISCLAIMS ALL IMPLIED WARRANTIES OF MERCHANTABILITY, SATISFACTION AND FITNESS FOR A PARTICULAR PURPOSE.

SEIT EXPRESS WARRANTIES WILL NOT BE ENLARGED, DIMINISHED, OR AFFECTED BY AND NO OBLIGATION OR LIABILITY WILL ARISE OUT OF, SEIT RENDERING OF TECHNICAL OR OTHER ADVICE OR SERVICE IN CONNECTION WITH THE PRODUCTS.

THE FOREGOING WARRANTIES AND REMEDIES ARE EXCLUSIVE AND IN LIEU OF ALL OTHER WARRANTIES AND REMEDIES. THE WARRANTIES SET FORTH ABOVE CONSTITUTE SEIT SOLE LIABILITY AND PURCHASER EXCLUSIVE REMEDY FOR ANY BREACH OF SUCH WARRANTIES. SEIT WARRANTIES EXTEND ONLY TO ORIGINAL PURCHASER AND ARE NOT EXTENDED TO ANY THIRD PARTIES.

IN NO EVENT SHALL SEIT, ITS OFFICERS, DIRECTORS, AFFILIATES OR EMPLOYEES BE LIABLE FOR ANY FORM OF INDIRECT, SPECIAL, CONSEQUENTIAL OR PUNITIVE DAMAGES, ARISING OUT OF THE USE, SERVICE OR INSTALLATION OF THE PRODUCTS, WHETHER SUCH DAMAGES ARISE IN CONTRACT OR TORT, IRRESPECTIVE OF FAULT, NEGLIGENCE OR STRICT LIABILITY OR WHETHER SEIT HAS BEEN ADVISED IN ADVANCE OF THE POSSIBILITY OF SUCH DAMAGES. SPECIFICALLY, SEIT IS NOT LIABLE FOR ANY COSTS, SUCH AS LOST PROFITS OR REVENUE, WHETHER DIRECT OR INDIRECT, LOSS OF EQUIPMENT, LOSS OF USE OF EQUIPMENT, LOSS OF SOFTWARE, LOSS OF DATA, COSTS OF SUBSTITUANTS, CLAIMS BY THIRD PARTIES, OR OTHERWISE.

NOTHING IN THIS LIMITED WARRANTY SHALL SEEK TO EXCLUDE OR LIMIT SEIT LIABILITY FOR DEATH OR PERSONAL INJURY RESULTING FROM ITS NEGLIGENCE OR ITS FRAUDULENT MISREPRESENTATION OF TO THE EXTENT THAT IT CANNOT BE EXCLUDED OR LIMITED BY APPLICABLE LAW.

To obtain service under warranty you must obtain a Returned Material Authorization (RMA) number from customer support. Customers with warranty claims issues may access the SEIT worldwide customer support network through the APC web site: www.apc.com. Select your country from the country selection drop down menu. Open the Support tab at the top of the web page to obtain information for customer support in your region. Products must be returned with transportation charges prepaid and must be accompanied by a brief description of the problem encountered and proof of date and place of purchase.